

GR-HB-100WA High Bay Lights

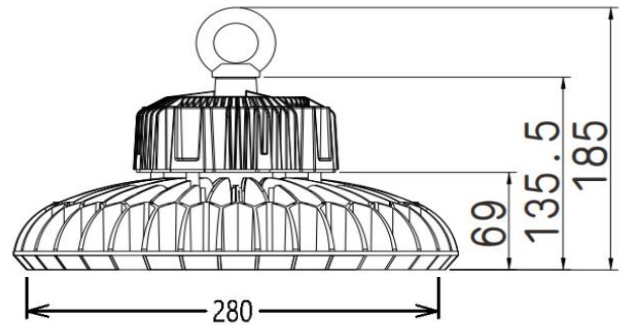

Dimension



Unit:mm

Description&Feature

LED high bay light,delivers a superior LED alternative that's up to 60% more energy efficient than the conventional HPS,Metal halide bay light retrofits. It is also ideal for all industrial lighting applications as well as public indoor spaces,such as warehouses, bus stations, Mine,Factories.,etc.

Its lifetime can be up to 10years. The other extra function such as dimming/ emergency backup also can be available.

Light Distribution Curve

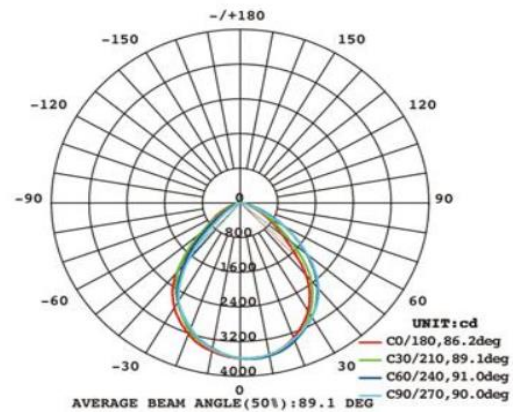

Specification

Model	GR-HB-100WA
Dimension(mm)	Ø280*H69mm
Outcut	/
Power	100W±5%
LED Chips brand	Philips/Osram/Bridgelux SMD3030 133PCS
Lumens	12000-14000lm
Color temperature	3000K/4000K-4500K/6000K-6500K
Driver	Isolated driver/Meanwell/Philips/DONE Brand driver(Round/Square options)
Input voltage	100-240VAC / 220-240VAC 50/60Hz
Power factor	>0.95
CRI	>80
SDCM	<5
Working life	>50000Hrs
Efficiency	>90%
Materials	Die-cast aluminum+PC
Beam angle	60/90°/120° options
THD	<10%
IP Grade	IP65 waterproof
Dimmable	No. but it is ok to do Triac/0-10V/DALI Dimming if needed
Working temperature	-30°C~+55°C
Package	35*35*17CM/pcs/CTN
Standard	CE LVD EMC RoHs
Warranty	2/3/5Years options