

GR-HB-150WEX Explosion proof High Bay

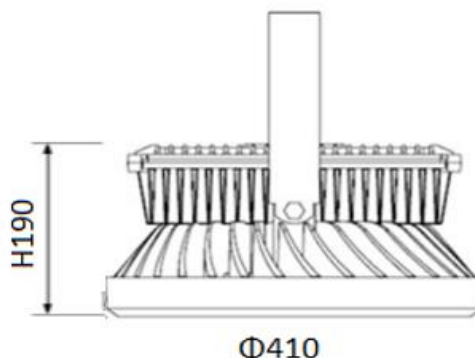

Dimension



Unit:mm

Description&Feature

This Explosion-proof high bay light, delivers a superior LED alternative that's up to 60% more energy efficient than the conventional HPS, Metal halide bay light retrofits.

It is also ideal for all industrial lighting applications as well as public indoor spaces, such as warehouses, bus stations, Mine, Factories, etc.

Its lifetime can be up to 5 years. The other extra function such as dimming/ emergency backup also can be available.

Light Distribution Curve

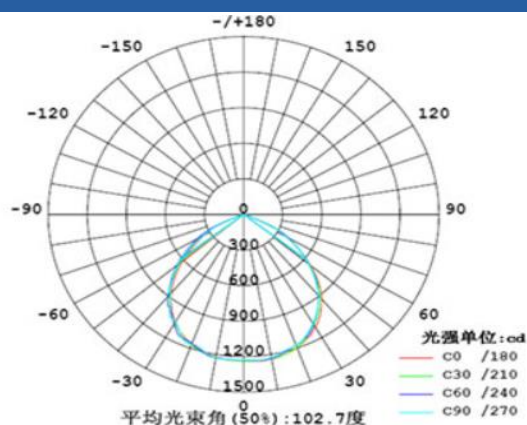

Specification

Model	GR-HB-150WEX
Dimension(mm)	Ø410*H190mm
Outcut	/
Power	150W±5%
LED Chips brand	Bridgelux
Lumens	13000-14500lm
Color temperature	3000K/4000K-4500K/6000K-6500K
Driver	Meanwell/Philips/DONE Brand
Input voltage	100-240VAC / 220-240VAC 50/60Hz
Power factor	>0.95
CRI	>80
SDCM	<5
Working life	>50000Hrs
Efficiency	>89%
Materials	Die-cast aluminum+Glass lens
Beam angle	45/100°
THD	<15%
IP Grade	IP65 waterproof
Dimmable	No. but it is ok to do Triac/0-10V/DALI Dimming if needed
Working temperature	-30°C~+55°C
Package	45*45*22cm/pcs/CTN
Standard	CE LVD EMC RoHs
Warranty	2/3/5Years options