

GR-MLL-20WTL Magnetic Track Light

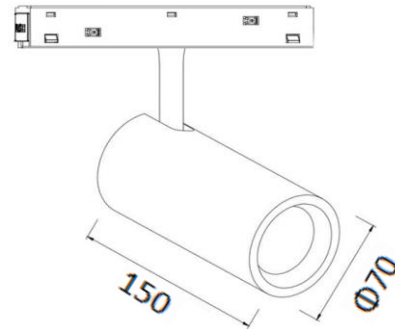

Dimension



Unit:mm

Description&Feature

This is 22mm width type magnetic track spot lights, only work with 22mm type magnetic track. It is with magnetic parts with small clips, fast to do installation and freely move it on the track. It is made of aluminum body and reflectors, black/white powder coated. Only work with DC48V voltage.

Its lifetime can be up to 50000Hrs.The other extra function such as 0-10V, DALI dimmable or Zigbee smart controller available.

Light Distribution

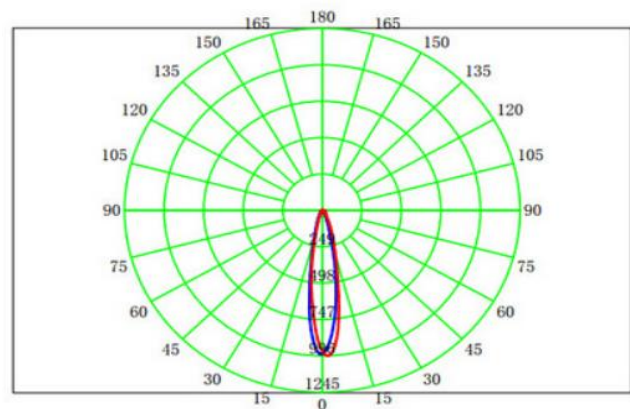

Specification

Order Model	GR-MLL-20WTL
Dimension(mm)	Φ70mm*150mm
Power	20W±5%
Input voltage	DC48V
LED Chips brand	Bridgelux/CREE COB
Lumens	1750-2000lm
Color temperature	3000K/4000K-4500K/6000K-6500K
Driver	Have to work with a DC48V Power supply, don't included DC48V power supply
Installation	Track
Rotation	360°rotation
CRI	>90
SDCM	<5
Working life	>50000Hrs
Efficiency	>87%
Materials	Die-cast aluminum,Black/White finished optional
Beam angle	24°/36°
IK Rate	IK07
IP Grade	IP22 indoor use only
Dimmable	No. but it is ok to 0-10V /DALI or Zigbee
Working temperature	-25°C~+50°C
Storage temperature	-30°C~+55°C
Standard	CE LVD EMC RoHs
Warranty	2/3/5Years